



Subsea Connectors

Burton

Electro Oceanic

 **COOPER** Interconnect



Solutions You
Can Trust In
Challenging
Conditions

5500 Series Accessories

BURTON

A number of accessories are available for the 5500 Series. Some are shown on this page. Please contact the factory for specific requests.

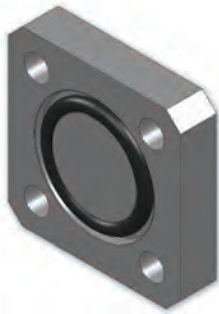

FCR Mounting Cover	
Size	Part Number
15	5106-1500-0000
16	5106-1600-0000
20	5106-2000-0000
24	5106-2400-0000
32	5106-3200-0000

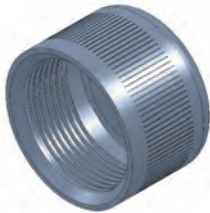

Receptacle Pressure Cap (SS)	
Size	Part Number
15	5101-1500-0000
16	5101-1600-0000
20	5101-2000-0000
24	5101-2400-0000
32	5101-3200-0000

Pressure caps rated to 500psi



Dummy Plug	
Size	Part Number
15	5501-15XX-0000
16	5501-16XX-0000
20	5501-20XX-0000
24	5501-24XX-0000
32	5501-32XX-0000

Dummy Plugs need to be used when full working pressure is required. Dummy Plugs are available for all sizes of cables and receptacles. Size the dummy plug as you would the mating connector.



Receptacle Dust Cap (hard rubber)	
Size	Part Number
15	6700-0124-0151
16	6700-0124-0161
20	6700-0124-0201
24	6700-0124-0241
32	6700-0124-0321

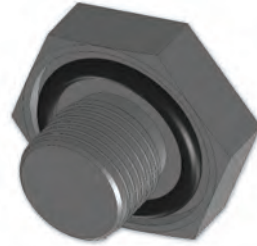

BCR Mounting Plug	
Size	Part Number
15	5107-1500-0000
16	5107-1600-0000
20	5107-2000-0000
24	5107-2400-0000
32	5107-3200-0000



BCR Retaining Ring	
Size	Part Number
15	5109-1500-0000
16	5109-1600-0000
20	5109-2000-0000
24	5109-2400-0000
32	5109-3200-0000



Plug Dust Cap (hard rubber)	
Size	Part Number
15	6700-0125-0151
16	6700-0125-0161
20	6700-0125-0201
24	6700-0125-0241
32	6700-0125-0321

5500 Series Custom Solutions

COOPER Interconnect



Shell Size 9



Plug Size 48

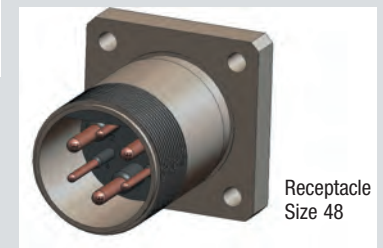

Receptacle Size 48

BURTON

Cooper Interconnect has expanded in both directions on our line of 5500 series Rubber Molded Metal Shell connectors. Our “Mini” shell size 9 connector is only 1/2” in diameter. Ideal for small instrumentation, cameras, or any application where space is an issue. We also expanded our line for very large “high-current” shell size 48 connectors and beyond. This connector can accommodate high current requirements for underwater motors, pumps and windfarms at sea.

6600 Series Assembly

BURTON

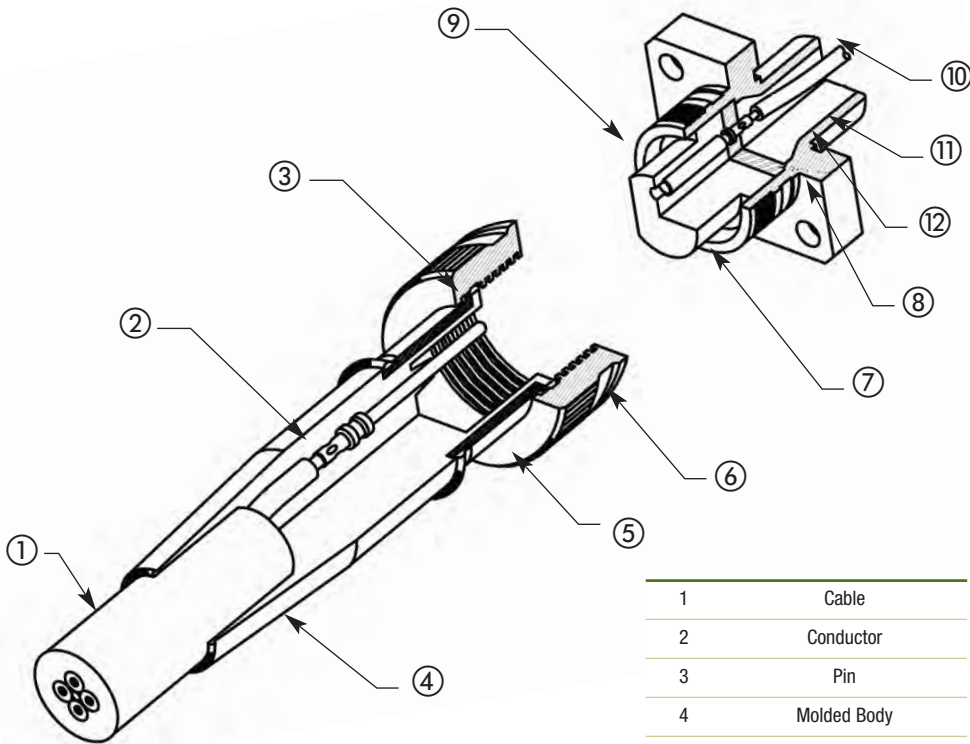

Part Number System

66 0 1 - 24 20 - 0004

Length in feet

Number of contacts

Shell size

Style:

- 1-CCP
- 2-CCR
- 6-FCR
- 7-BCR

Special designation:

- A-Attachable
- R-Right angle
- 0-600v (standard)
- 1-1000v
- 2-2000v
- 3-3000v
- 9-1100v (special)

Series

1	Cable
2	Conductor
3	Pin
4	Molded Body
5	Metal Shell
6	Locking Ring
7	Recept. Face
8	Metal Shell
9	Socket
10	Pigtails
11	Epoxy Backfill

Data and Specifications

Pressure Rating	10,000 PSI
Voltage Rating	600 – 3000
Ampacity	See Appendix

Materials

Contacts	High cond. copper alloy
Penetrator Shell	316L SS (passivated)
Penetrator Body	Integrally molded elastomer
Cable	UL SOW-A or Mil-C-915
Pigtails	Mil-W-16878

The 6600 Series is an extremely rugged and reliable underwater electrical connector. It is the alternate Burton connector series with pin in the plugs and sockets in the receptacles (the inverse of the 5500 series).

Occasionally, it is desirable to run power from the receptacle to the plug (for example a power supply or battery pack). In these instances, use the 6600 Series. For safety reasons, it is desirable to never have power available on the pin side. For reverse (standard) power applications, refer to Burton's 5500 Series. Along with the Burton 5500 Series, the 6600 Series has for over two decades become the industry standard connector for applications, which require reliable service in severe situations. The rugged metal shells, recessed pins, and face type seals assure dependable service in the most demanding situations.

6600 Series Overview



BURTON

Like the 5500 Series, the 6600 Series has a number of features which are designed to make them rugged and reliable even in severe service. Use the Burton 6600 Series for mission critical applications where you need power flowing in opposite the usual direction.

6600 Series Features

Burton 6600 Series connectors have no O-Ring seal between the plug and receptacle. That seal is a face type seal integrally molded as part of the plug and cannot fall off.

Stub acme threads are used on all shell sizes. Stub acme threads are difficult to cross thread or damage.

The electrical contacts have crimp connections to the conductor; not solder joints. Crimp contacts have superior flex life compared to soldered joints.

All elastomer to metal bonding surfaces are sandblasted, cleaned and primed. Then units are molded under several thousand pounds of pressure for 20 or more minutes at 300+ degrees. This assures a complete bond which prevents water migration.

Receptacle Features

Like the Cooper Interconnect 5500 Series, the 6600 Series receptacles have a unique water blocking system. The water blocking exists down to the conductor level. This means that in the event of a catastrophic failure of the connector system such as the plug being torn away from the receptacle – water will not enter your valuable equipment. Many competing connector lines do not water block down to the conductor level.

Plug Features

The plugs have a metal shell under the elastomeric body. It makes them very rugged and resistant to flexing damage.

The pins are completely contained within the envelope of the metal shell. This means that the pins will not be bent or damaged when the connector has been impacted or stepped on.

The plug contacts are completely bonded and isolated from each other. This means that if the cable jacket is damaged and water migrates into the plug, electrical integrity can be maintained.

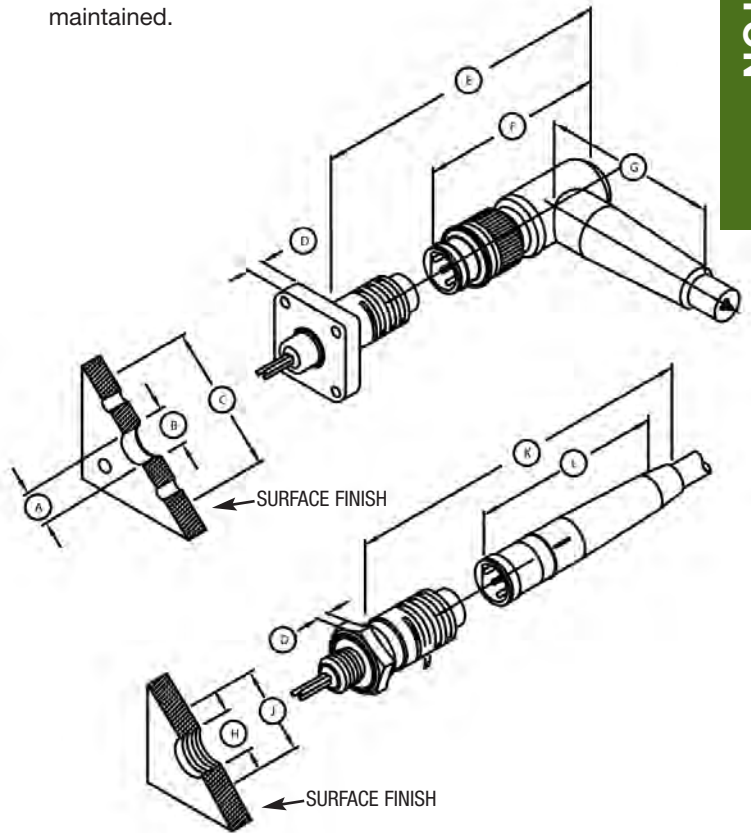

6600 Series Assembly Dimensions in English (Metric)

Shell Size	A	B	C	D	E	F	G	H	J	K	L
16	0.64 (16.3)	0.66 (16.8)	2.12 (54.6)	0.375 (9.5)	---	---	---	0.79 (20.1)	1.44 (36.6)	3.72 (94.5)	2.15 (54.6)
20	0.77 (19.6)	0.79 (20.1)	2.28 (57.9)	0.375 (9.5)	4.00 (101.6)	3.24 (82.3)	2.90 (73.7)	0.79 (20.1)	1.44 (36.6)	5.26 (133.6)	2.14 (54.4)
24	1.02 (25.9)	1.04 (26.4)	2.63 (66.8)	0.375 (9.5)	4.50 (114.3)	3.87 (98.3)	3.25 (82.6)	1.05 (26.7)	1.73 (43.9)	5.87 (149.1)	2.30 (59.2)
32	1.52 (38.6)	1.54 (39.1)	3.50 (88.9)	0.375 (9.5)	5.13 (130.3)	4.50 (114.3)	4.59 (116.6)	1.55 (39.4)	2.31 (58.7)	6.57 (166.9)	3.50 (88.9)

6600 Series Configurations

Please refer to the illustration on the facing page. The receptacles (which have socket contacts) are shown on the top. The plugs (which have pin contacts) are shown on the bottom. This pin/socket relationship is opposite of the 5500 Series. It is used for occasions where you wish power to flow from the receptacle to the plug. For safety reasons, the possibility of live power on pins should not be allowed. If the reverse contact arrangement is required, please refer to the Burton 5500 Series.

The descriptions below correspond to the illustration to the right. The part numbers refers to the first 4 digits of the part number.

BCR Bulkhead Connector Receptacle (6607)

Less expensive than the FCR, this is the standard receptacle mount. It may be used with any plugs. When using the BCR with a right angle plug (CCP-RA), a BCR retaining ring must be used instead of tapped threads. This is due to keyway orientation.

FCR Flange Connector Receptacle (6606)

Like the BCR, this is a mounted receptacle. It is more expensive since it is machined from a larger block of stainless steel. It is also more difficult to mount since it requires 5 holes instead of 1. However, it is ideal for use with the right angle plug since keyway orientation can be controlled. It is possible to get this receptacle with an extra O-Ring seal mounted on the F surface for an additional piston type seal (available by special order).

CCR Cable Connector Receptacle (6602)

An in-line receptacle mounted on a cable. It can be used as part of a cable splice unit or other specialized application.

CCR-AT, Attachable (66A2)

Used in the same applications as the CCR except that it is designed to be attached to its cable by the customer.

CCP Cable Connector Plug (6601)

The standard plug for most applications. Like all of the plugs, it mates to any of the receptacles. This plug is molded to cable at the Cooper Interconnect factory.

CCP-RA Cable Connector Plug, Right Angle (66R1)

This plug should be used when the cable must exit the receptacle at a 90-degree angle. Normally, the FCR is recommended for use with the right angle plug to assure keyway orientation.

CCP-AT Cable Connector Plug, Attachable (66A1)

Used in the same applications as the CCP except that it is designed to be attached to its cable by the customer. A variation of this plug is available as a PBOF (pressure balanced oil filled) assembly. The connector shell is modified to accept a new backshell, which has an oil fill port and a hose attachment. Please consult the factory for details.

6600 Series Dimensions in English (Metric)

Shell Size	6A thd*	6B	6C	6D	6E	6F	6G	6H thd*	6J	6K	6L	6M dia	6N	6P dia	6R	O-Ring	6S	6T dia	6U	6X
16	1-9	3.01 (76.5)	1.17 (29.7)	1.13 (28.6)	1.50 (38.1)	0.50 (12.7)	0.375 (9.53)	5/8-18	1.125 (28.6)	1.625 (41.28)	—	0.615 (15.62)	—	—	1.72 (43.7)	-116	0.837 (21.26)	0.219 (5.563)	—	—
20	1-1/4-9	3.74 (95.0)	1.50 (38.1)	1.25 (31.8)	1.50 (38.1)	0.50 (12.7)	0.375 (9.53)	3/4-16	1.25 (31.8)	1.75 (44.45)	2.90 (73.7)	0.74 (18.80)	1.59 (40.4)	1.06 (26.9)	1.62 (41.1)	-118	1.087 (27.61)	0.281 (7.137)	3.24 (82.3)	4.12 (104.7)
24	1-1/2-9	4.33 (110.0)	1.75 (44.5)	1.50 (38.1)	1.50 (38.1)	0.50 (12.7)	0.375 (9.53)	1-14	1.50 (38.1)	2.00 (50.80)	3.57 (73.7)	0.99 (25.15)	1.68 (42.7)	1.32 (33.5)	1.62 (41.1)	-122	1.32 (33.63)	0.281 (7.137)	3.87 (98.3)	4.78 (121.4)
32	2-9	5.07 (128.8)	2.25 (57.2)	2.00 (50.8)	1.50 (38.1)	0.50 (12.7)	0.375 (9.53)	2-9	2.00 (50.8)	2.63 (66.68)	4.59 (116.6)	1.49 (37.85)	1.70 (43.2)	1.81 (46.0)	1.62 (41.1)	-130	1.81 (46.02)	0.344 (8.738)	4.50 (114.3)	5.47 (138.9)

6600 Series Configurations

<p>BCR RECEPTACLE, BULKHEAD SOCKET INSERT 6607 SERIES</p>		
<p>FCR RECEPTACLE, FLANGE SOCKET INSERT 6606 SERIES</p>		
<p>CCR RECEPTACLE, CABLE SOCKET INSERT 6602 SERIES</p>		
<p>CCR-AT RECEPTACLE, ATTACHABLE 66A2 SERIES</p>		
<p>CCP PLUG, CABLE PIN INSERT 6601 SERIES</p>		
<p>CCP-RA PLUG, RIGHT ANGLE PIN INSERT 66R1 SERIES</p>		
<p>CCP-AT PLUG, ATTACHABLE 66A1 SERIES</p>		

6600 Series Contact Arrangements

Face view of pin connectors shown. Attaching wire sizes are in parentheses.

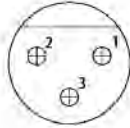

1603
(3 #16 AWG)



1608
(8 #18 AWG)

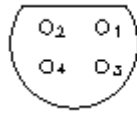

1604
(4 #18 AWG)



1606
(6 #18 AWG)

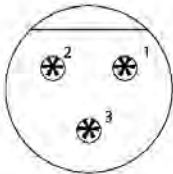

2003
(3 #16 AWG)

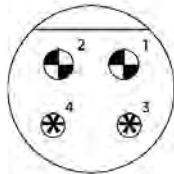

2004
(4 #16 AWG)

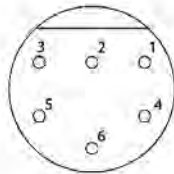

2006
(6 #18 AWG)

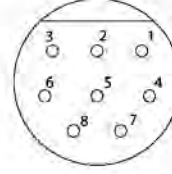

2008
(8 #18 AWG)

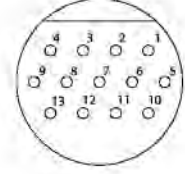

2013
(13 #18 AWG)

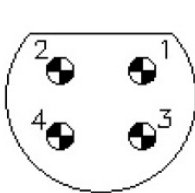

2404
(4 #12 AWG)

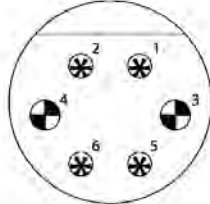

2406
(6 #16 AWG)

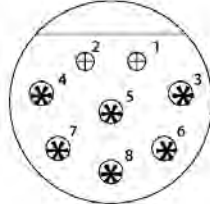

2408
(8 #16 AWG)

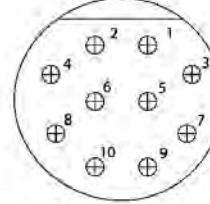

2410
(10 #16 AWG)

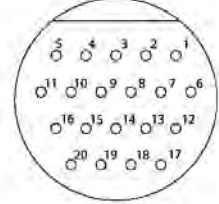

2420
(20 #18 AWG)

6600 Series Contact Arrangements



BURTON

Face view of pin connectors shown. Attaching wire sizes are in parentheses.

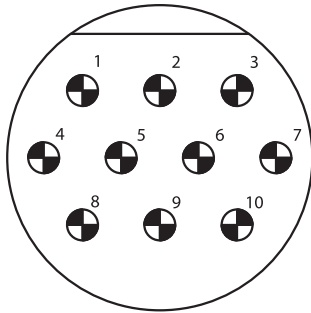

3210
(10 #16 AWG)

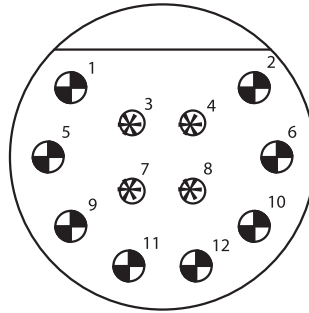

3212
(12 #16 AWG)

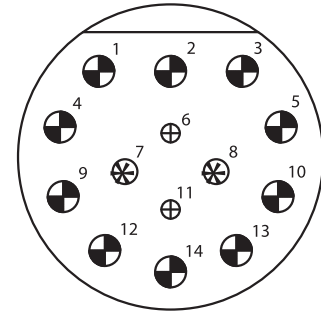

3214
(14 #16 AWG)

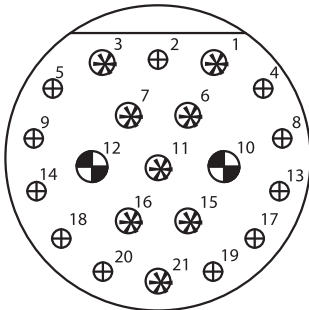

3221
(21 #16 AWG)

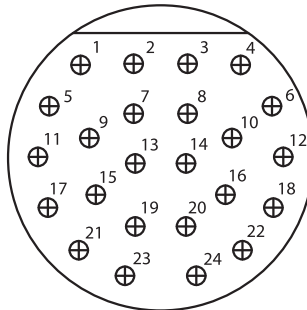

3224
(24 #16 AWG)

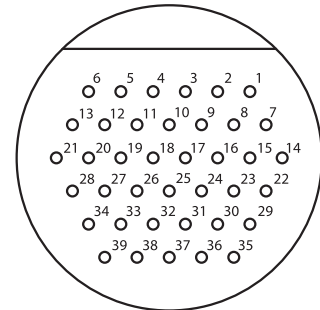

3239
(39 #18 AWG)

PIN DIAMETER	1/16 ○	3/32 ⊕	1/8 ⊗	5/32 ⊕	3/16 ●
--------------	--------	--------	-------	--------	--------

The contact patterns shown on these two pages are available for any connector type with the Cooper Interconnect 6600 Series. All Cooper Interconnect 6600 Series connectors are available in high voltage ratings. Please contact the factory for details.